

1	1	ZKLADOOS	DOOS MET BEVESTIGINGSMIDDELEN KLAPHEK 1100
2	2	ZBO0KLA	LEUNINGSTAANDER 50/50*1100 TBV KLAPHEK
3	2	ZKLAF150	KLAPHEK FRAME OPEN L/R H=1100 B=1500
Pos	Aantal	Struct. nr.	Omschrijving
Klant:			Amerikaanse projectie:
Referentie klant:			Print datum: 18-4-2025
Ons ordernr.:		Deze tekening is eigendom van Multi Profiel BV	
Datum: 18-10-2023		Getekend: JHU	
Producersen: Volgens EN1090-2 en exc.kl. 2		Rev.	
Conserveren: Poeder coating, indien THVZ: EN1461 met EN10346		Ee nh. <b>MM</b>	
Benaming: KLAPHEK B=1500 H=1100 (2X B=750) OPEN			Formaat <b>A4</b>
Tekening nr.: ZKLA1500			

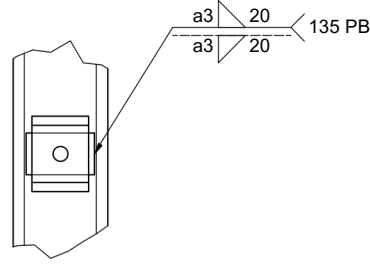

A

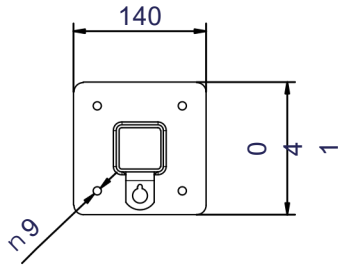
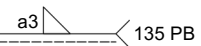
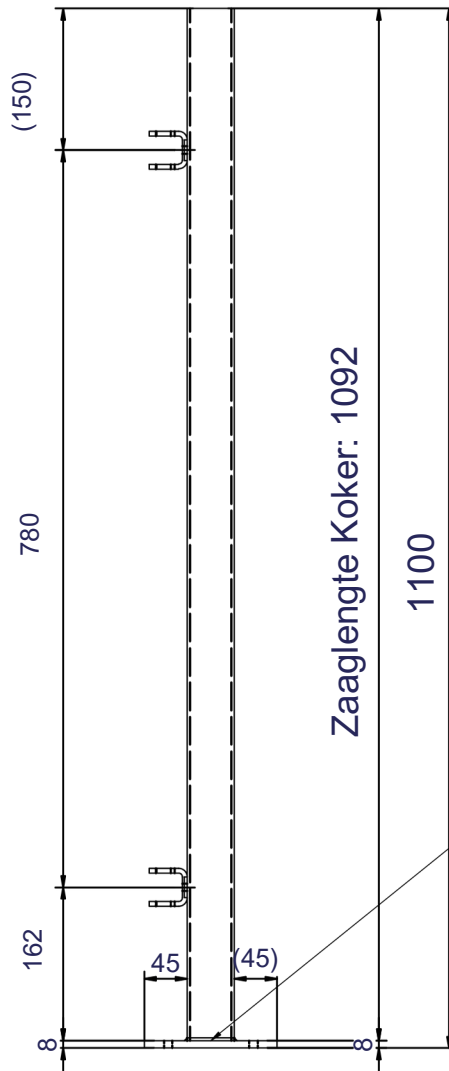
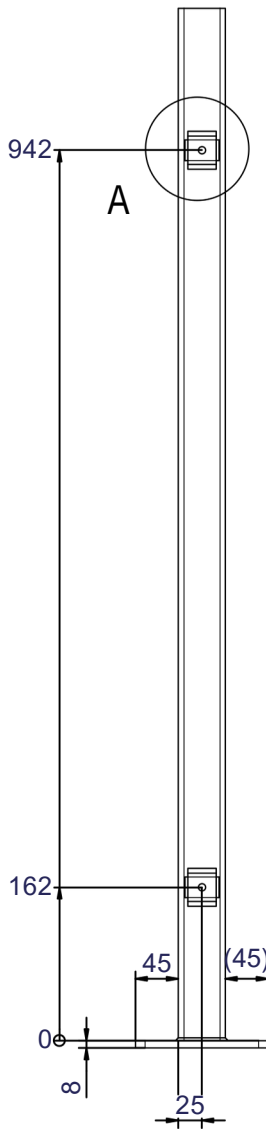
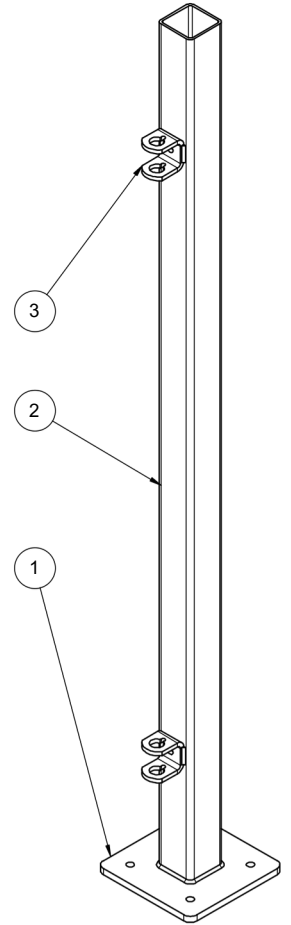

1	1	ZV14144	VOETPLAAT 140X140X8 4X Ø9
2	1	BU5050503-01 tbv ZBOKLA	KOKER 50X50X3 S235JRH ZAAGLENGTE KOKER =1092
3	2	ISB997160-BEUGEL	POORTSCHARNIER BEUGEL
Pos	Aantal	Struct. nr.	Omschrijving
		Klant:	Amerikaanse projectie:
		Referentie klant:	Print datum: 18-4-2025
Ons ordernr.:		Deze tekening is eigendom van Multi Profiel BV	
Datum: 15-9-2021		Getekend: JHU	
Produceren: Volgens EN1090-2 en exc.kl. 2		Bouwjaar:	
Conserveren: Poeder coating, indien THVZ: EN1461 met EN10346		Tekening nr.:	
Benaming: LEUNINGSTAANDER 50/50*1100 TBV Klaphek		ZB00KLA	
		Rev.	Eenh. <b>MM</b> Formaat <b>A4</b>

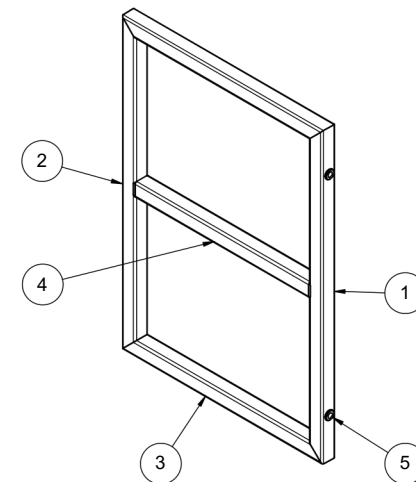
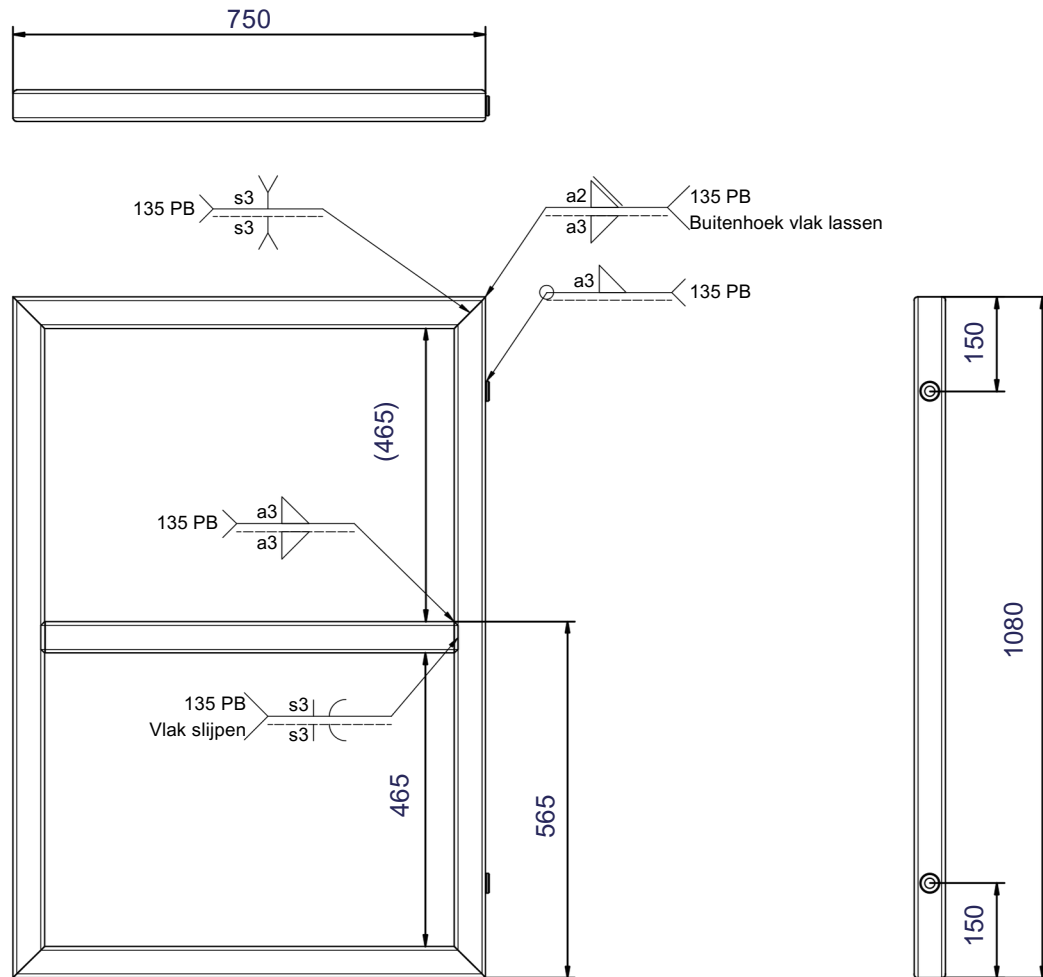

1	1	BU5050503-01 tbv ZKLF1100H	KOKER 50X50X3 S235JRH
2	1	BU5050503-02 tbv ZKLF1100H	KOKER 50X50X3 S235JRH
3	2	BU5050503-03 tbv ZKLAF150	KOKER 50X50X3 S235JRH
4	1	BU5050503-04 tbv ZKLAF150	KOKER 50X50X3 S235JRH
5	2	ISB997160-INLASMOER	POORTSCHARNIER INLASMOER M16
Pos	Aantal	Struct. nr.	Omschrijving

	Klant:	Amerikaanse projectie:
	Referentie klant:	Print datum: 18-4-2025
	Ons ordernr.:	
	Datum: 18-10-2023	Getekend: JHU
Producteren: Volgens EN1090-2 en exc.kl. 2	Bouwjaar:	Rev.
Conserveren: Poeder coating, indien THVZ: EN1461 met EN10346	Tekening nr.: ZKLAF150	Ee nh: MM
Benaming: KLAPHEK FRAME OPEN L/R H=1100 B=1500		Formaat: A4